

PILZ_5_D(700)

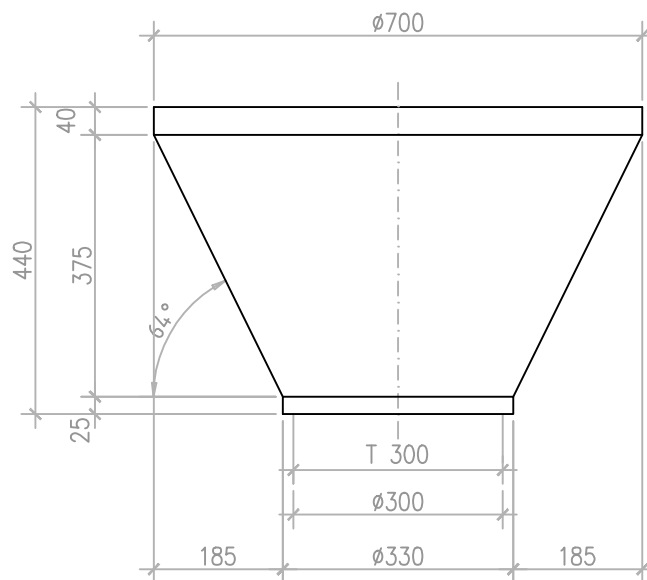
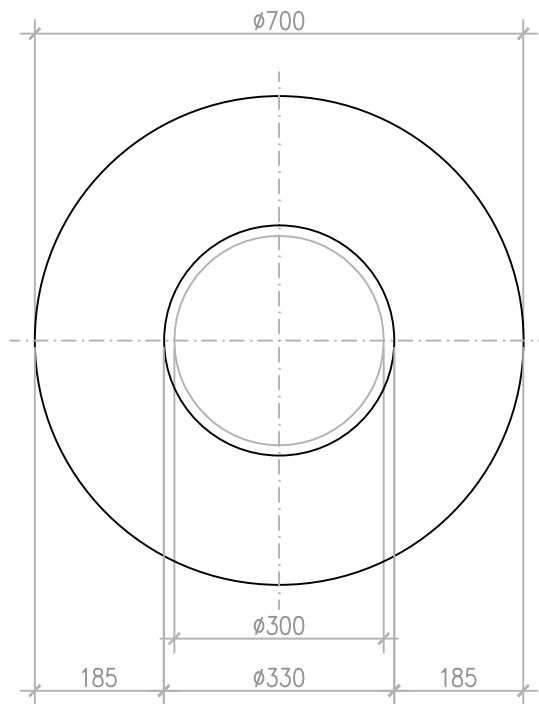

99 Liter
246 kg

ANLAGENUMMER: 5