

# PILZ\_5\_D(700)

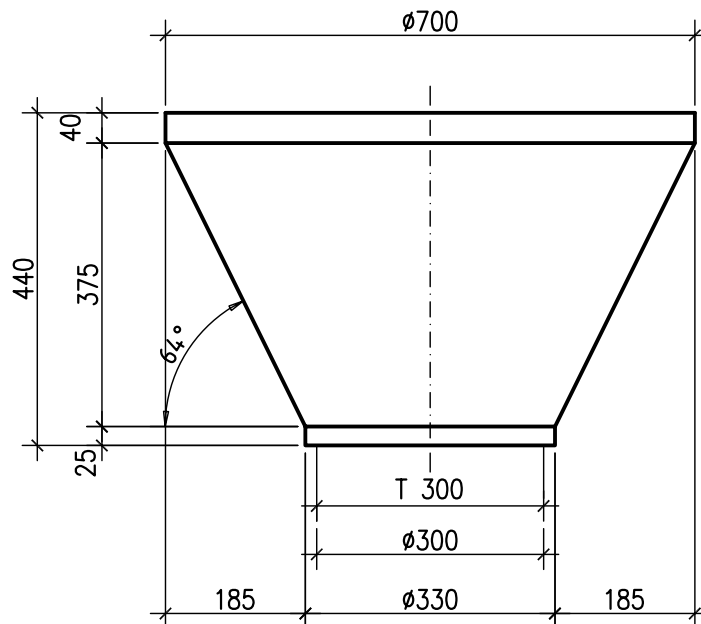
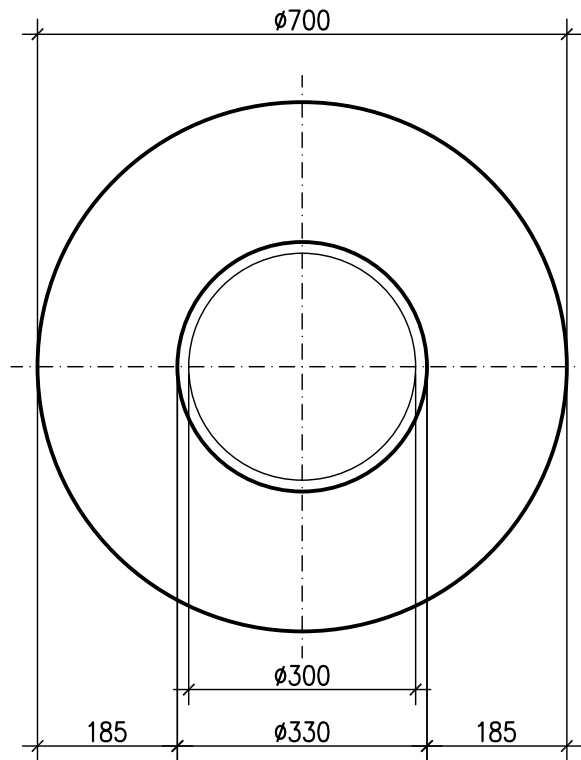

99 Liter 246 kg
--------------------

ANLAGENUMMER: 5