

PILZ_101_Q_V(850)

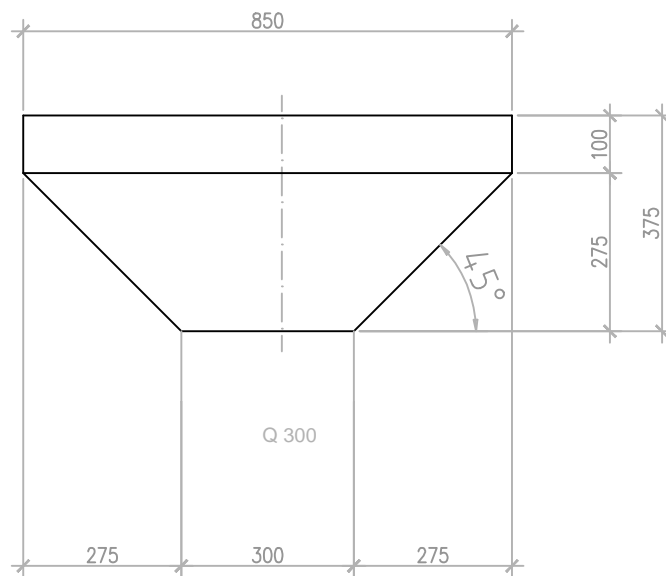
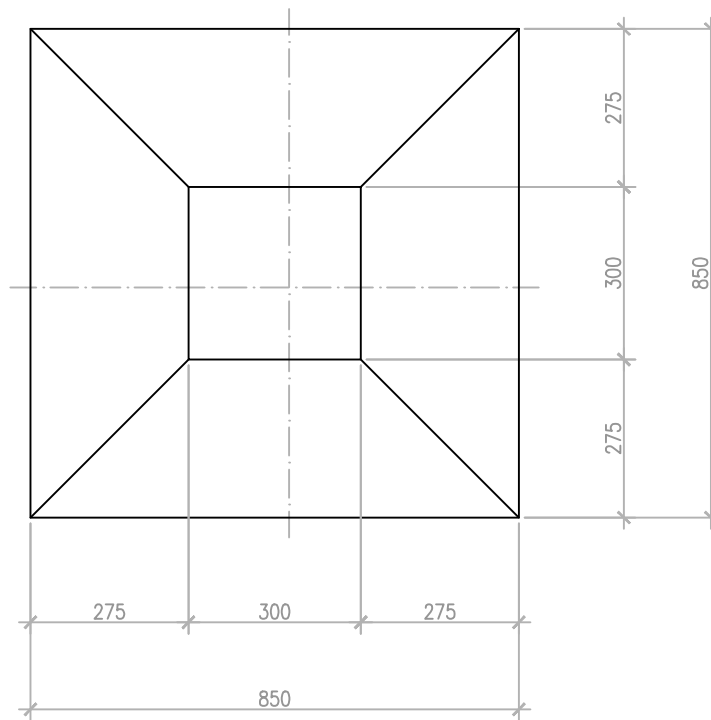

184 Liter
451 kg

ANLAGENUMMER: 101_1