

PILZ_14_D(500)

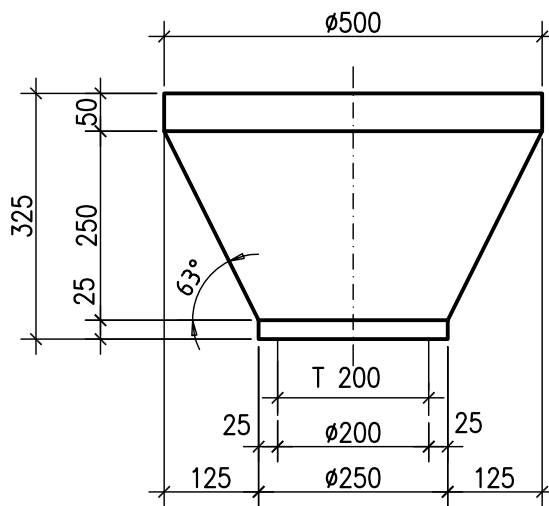
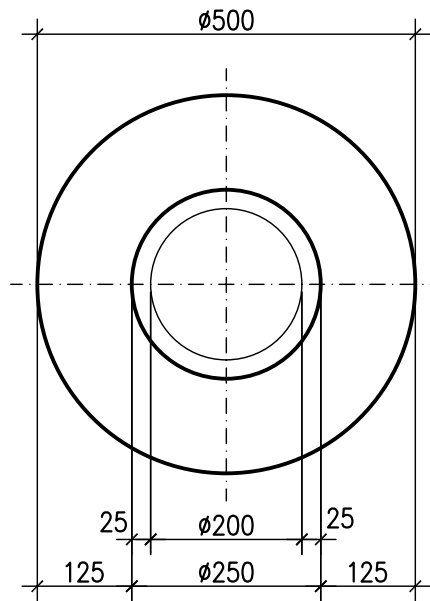

40 Liter
100 kg

ANLAGENUMMER: 14