

PILZ_16_P(720x940)

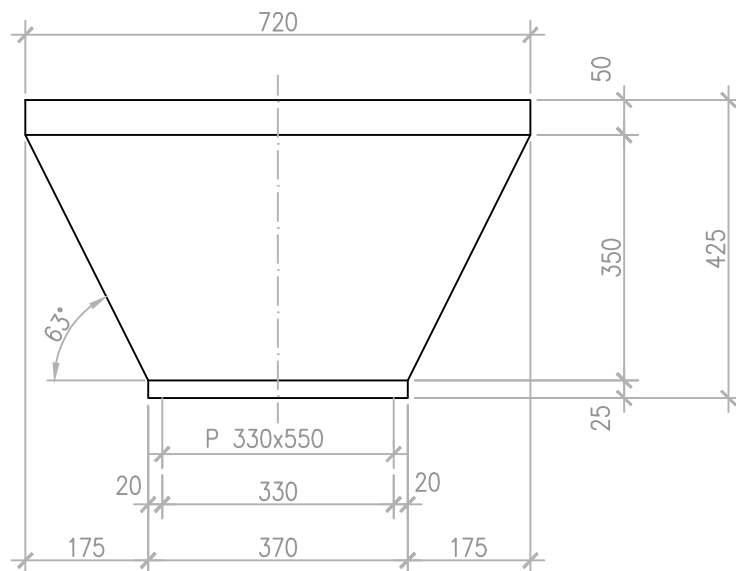
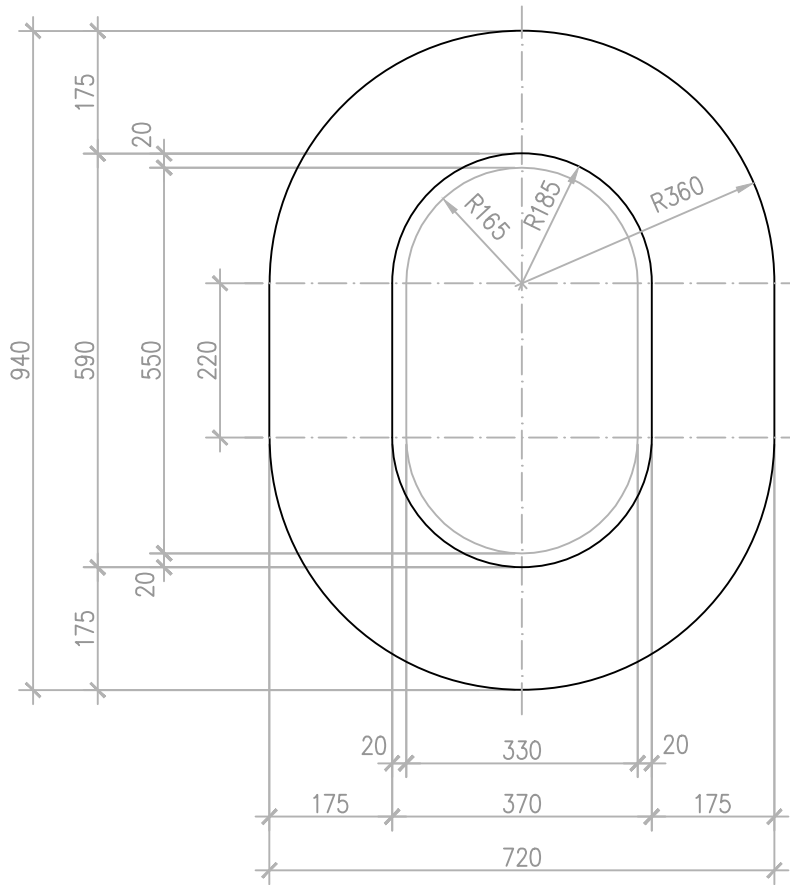

161 Liter
403 kg

ANLAGENUMMER: 16_1/16_2