

PILZ_19_D(400)

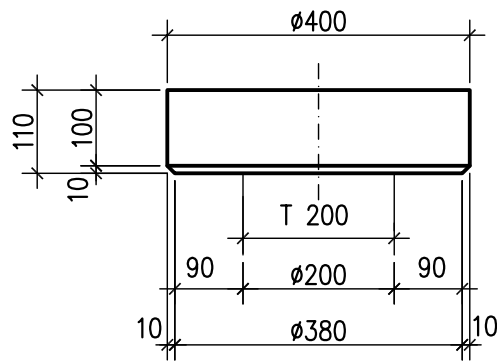
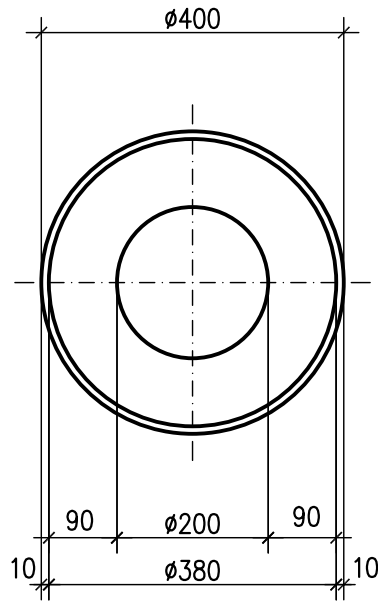

14 Liter
35 kg

ANLAGENUMMER: 19