

PILZ_34_P(600x810)

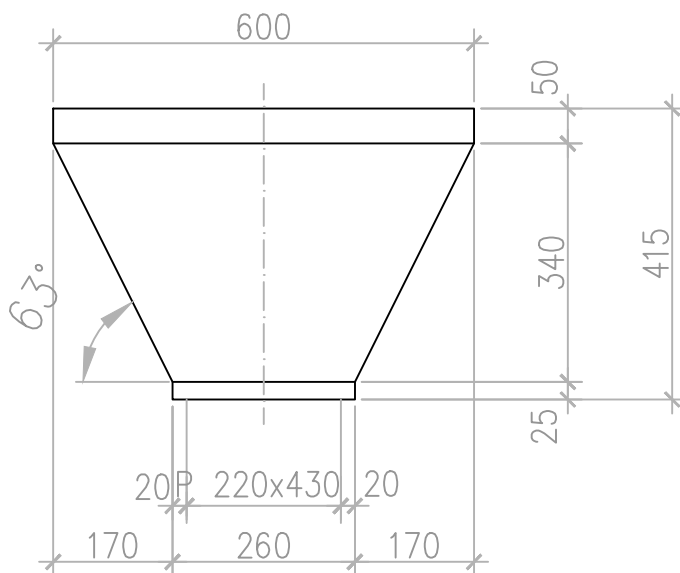
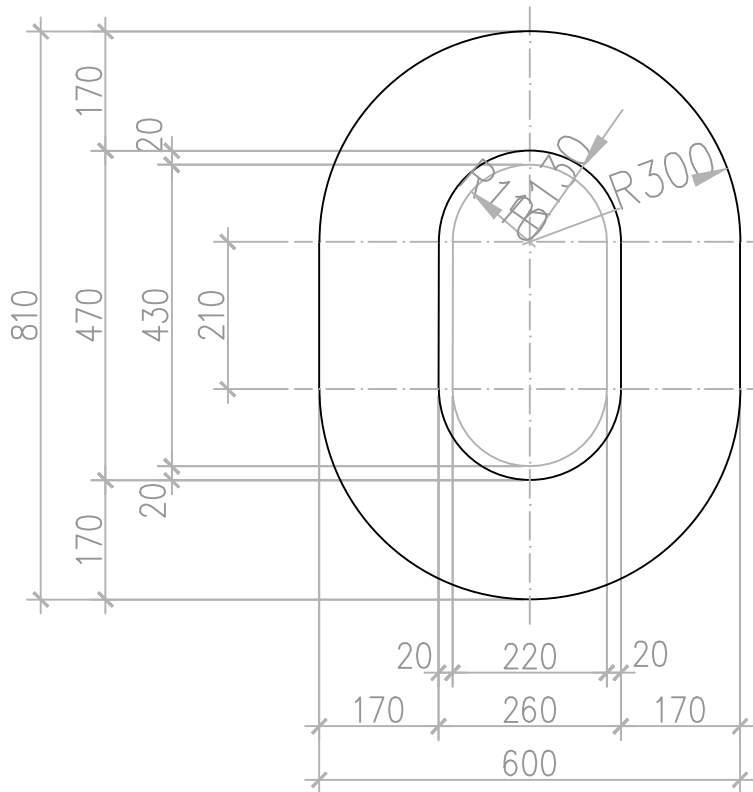

106 Liter
266 kg

ANLAGENUMMER: 34_1/34_2/34_3