

PILZ_35_D(900)

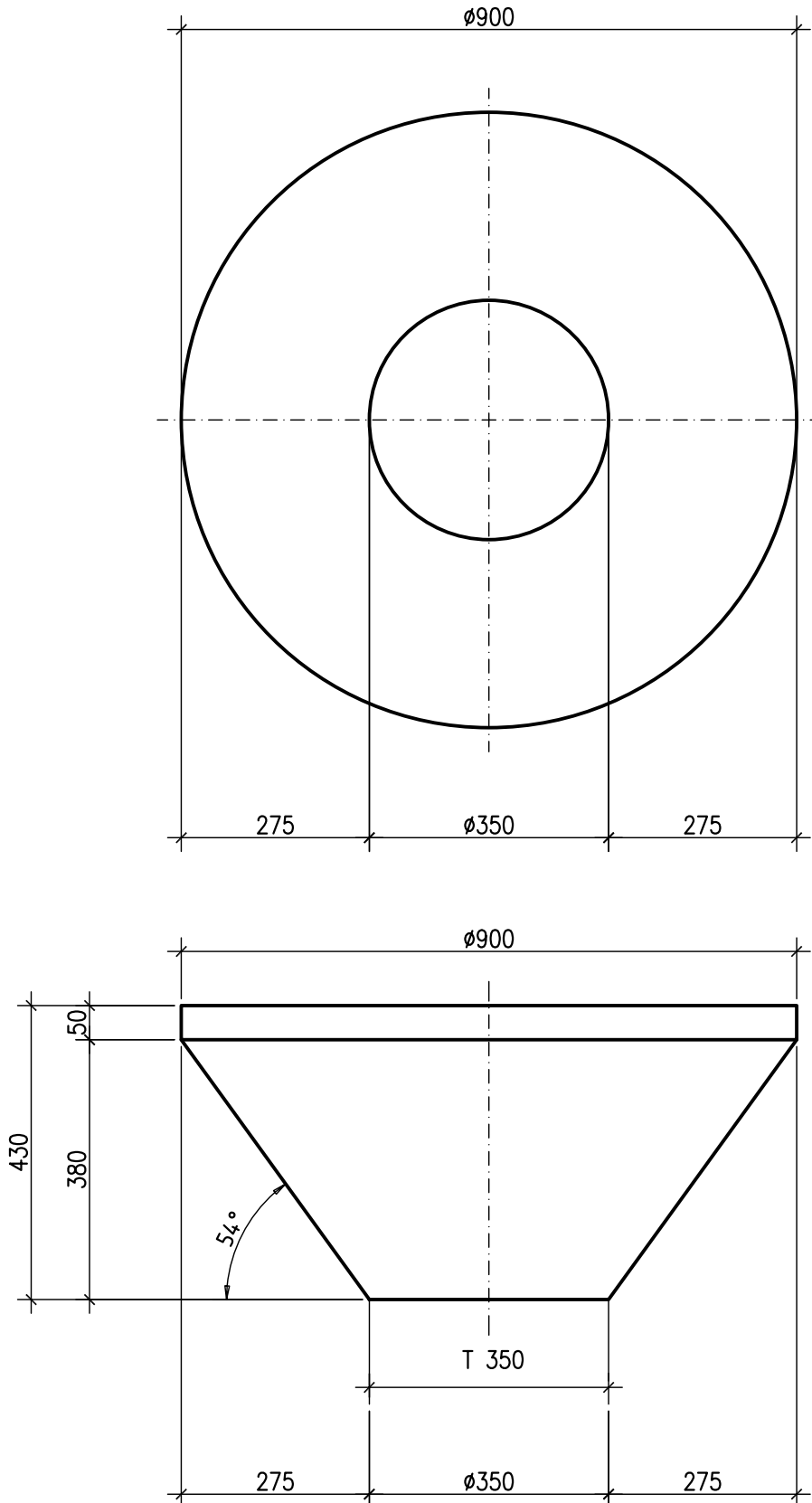

153 Liter 382 kg

ANLAGENUMMER: 35