

# PILZ\_52\_R\_V(1150x1700)

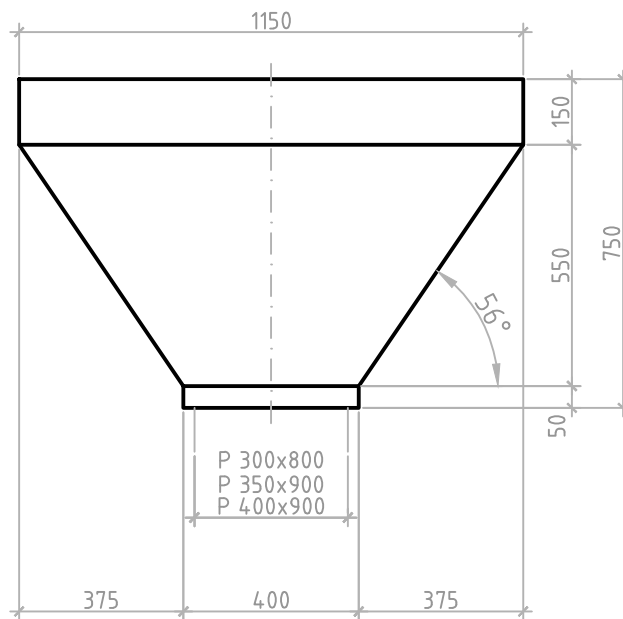
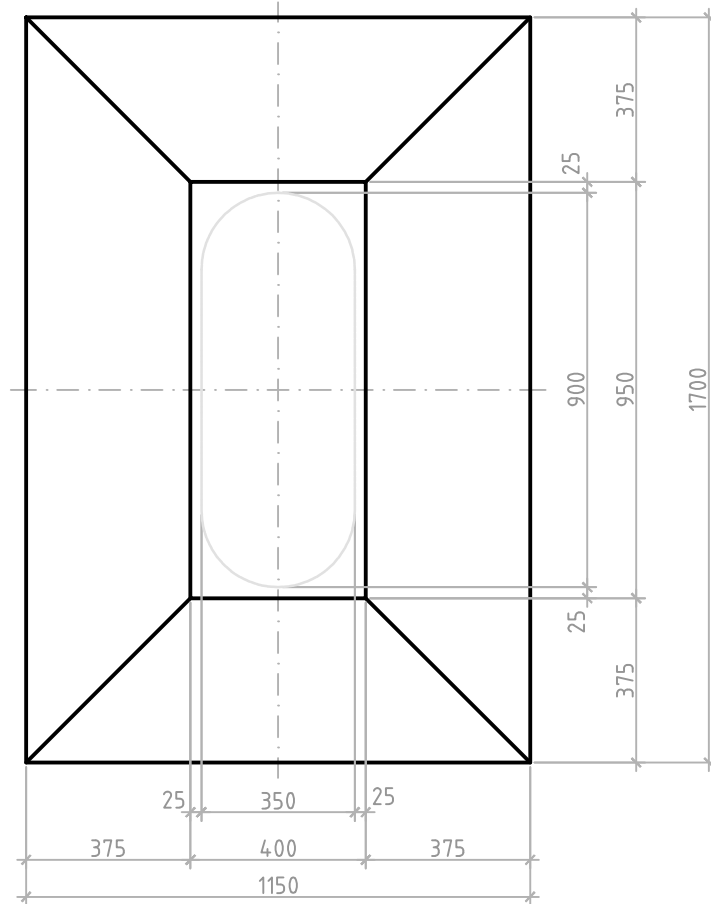

903 Liter  
2258 kg

ANLAGENUMMER: 52