

PILZ_52_R_V(1150x1700)

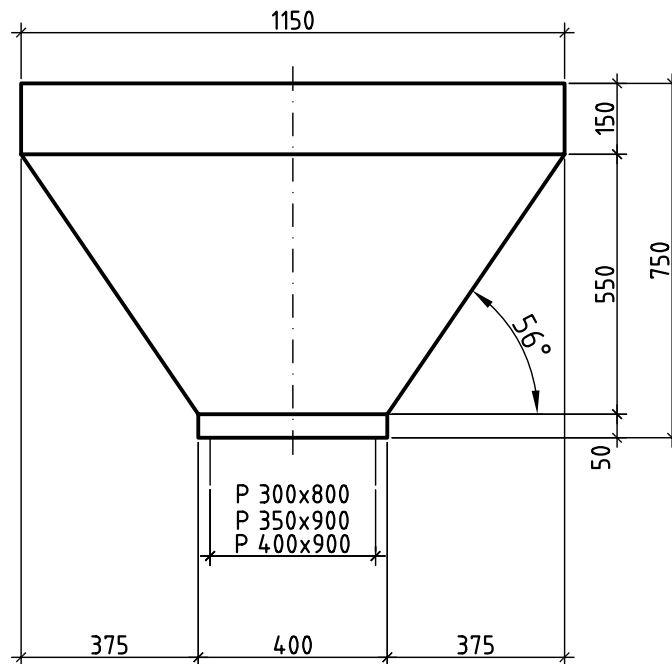
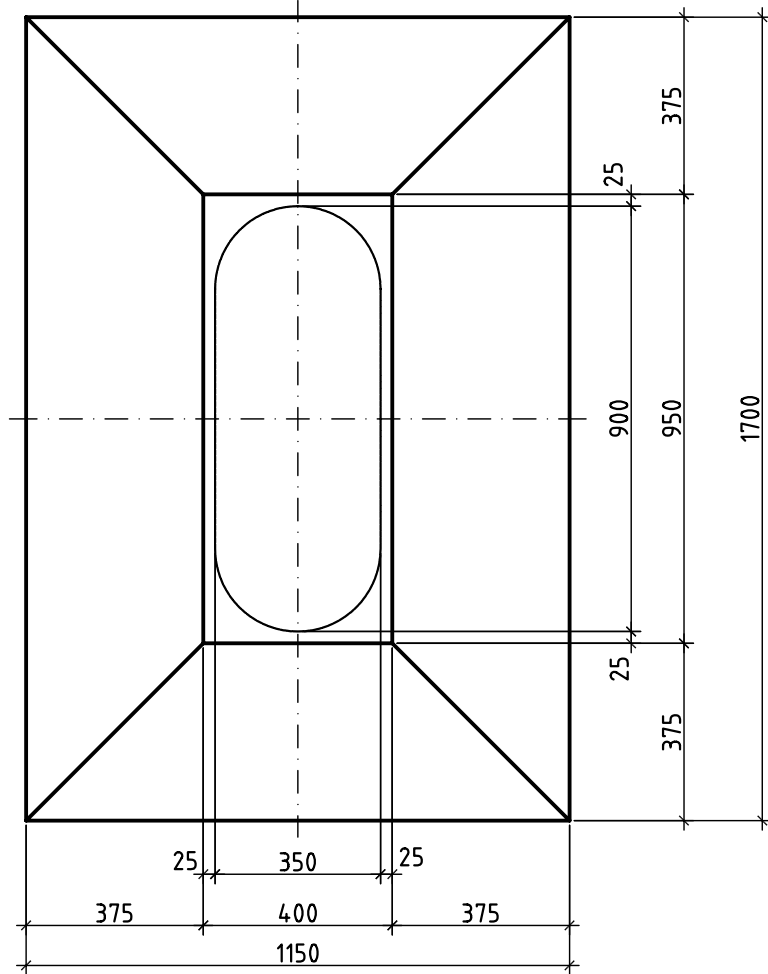

903 Liter
2258 kg

ANLAGENUMMER: 52