

PILZ_72_Q_V(900)

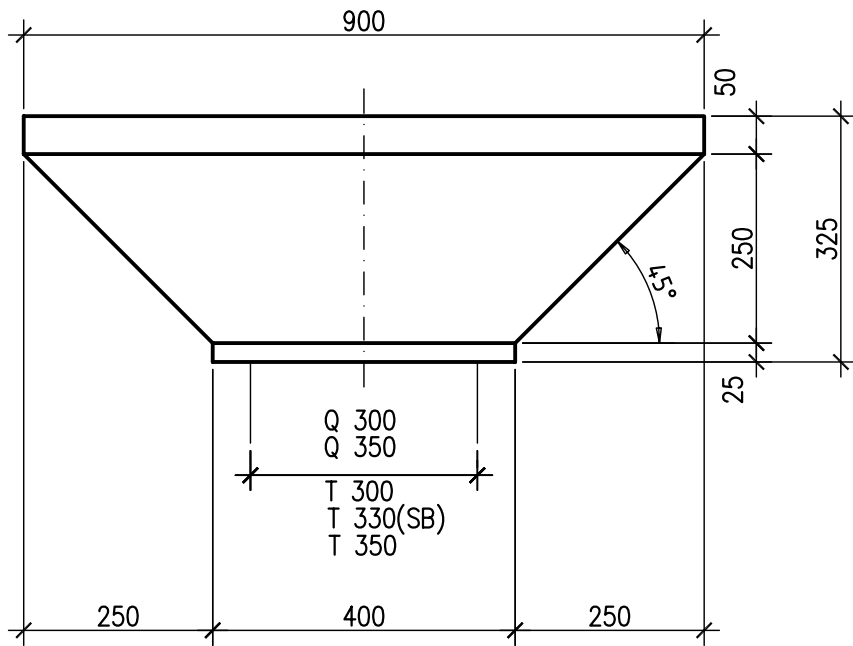
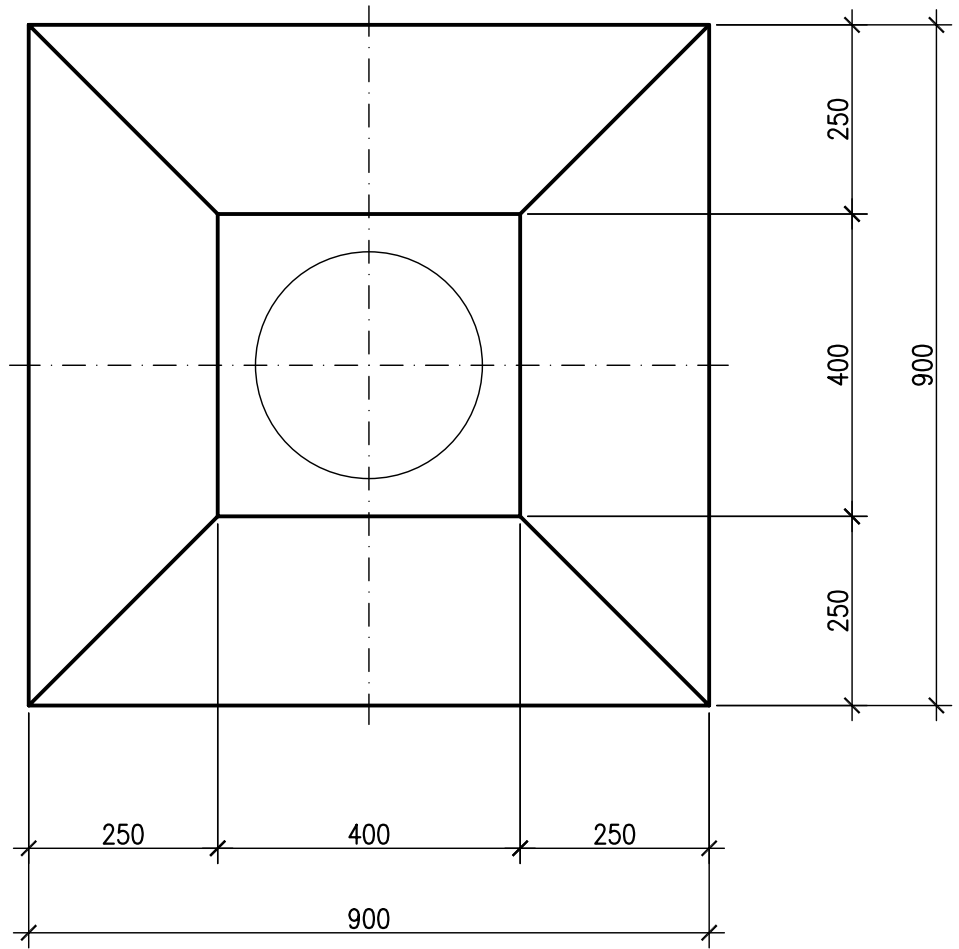

155 Liter
387 kg

ANLAGENUMMER: 72_1/72_2