

PILZ_74_Q_V(950)

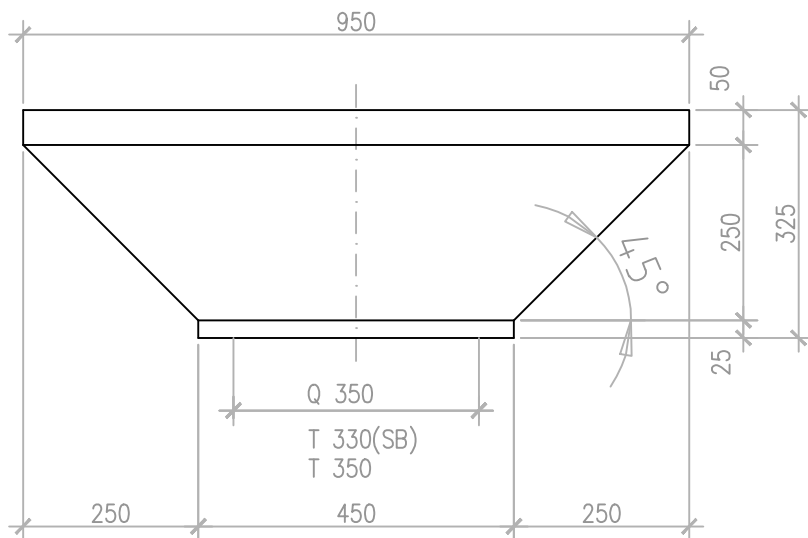
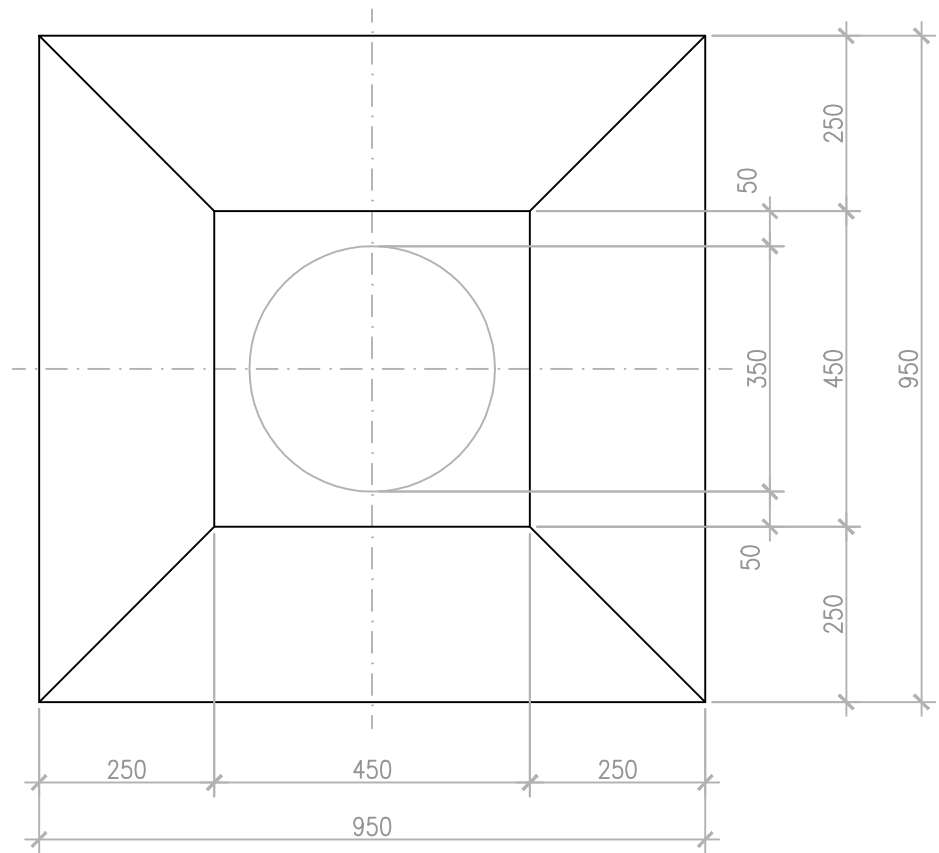

178 Liter
445 kg

ANLAGENUMMER: 74